

SAMSUNG

Enterprise IP Solutions

OfficeServ

(& DCS Systems)

User Guide for Digital Phones

DS-5038S

DS-5014S

DS-5007S



TELECOMS



Publication Information

Samsung Telecoms reserves the right without prior notice to revise information in this publication for any reason.

Samsung Telecoms also reserves the right without prior notice to make changes in design or components of equipment as engineering and manufacturing may warrant.

Disclaimer

Samsung Telecoms is not responsible for errors or problems arising from customers not installing, programming or operating their Samsung systems as described in this manual.

Copyright 2004 Samsung Telecoms (UK) Limited

All rights reserved. No part of this manual may be reproduced in any form or by any means – graphic, electronic or mechanical, including recording, taping, photocopy or information retrieval system – without express written permission of the publisher of this material.

Part No.: 18934

Version 1.0



ELECTRONICS

EU Declaration of Conformity (RTTE)

Samsung Electronics Co., Ltd.

259 Gongdan-Dong, Gumi-City Kyungbuk, Korea, 730-030

(factory name, address)

declare under our sole responsibility that the product
Digital Keyphone System "DCS-816"

to which this declaration relates is in conformity with

RTTE Directive 1999/5/EC (Annex II)
Low Voltage Directive 73/23/EEC
EMC Directive 89/336/EEC:92/31/EEC



By application of the following standards

EN55022 : 1998 Inc. A1: 2000*

.....
EN61000-3-2:1995 Inc. A1/A2:1998

.....
EN61000-3-3:1995, EN61000-4-2:1995 Inc. A1:1998, EN61000-4-3:1996 Inc. A1:1998

.....
EN61000-4-4:1995, EN61000-4-5:1995, EN61000-4-6:1996, EN61000-4-8:1993

.....
EN61000-4-11:1994, AS/NZS3548:1995

.....
EN60950 ; 1992+A1+A2+A3+A4+A11

.....
.....

(Manufacturer)

Samsung Electronics Co., Ltd
259, Gongdan-Dong, Gumi-City
Kyungbuk, Korea, 730-030

.....
2001-03-31 TE Jang

(place and date of issue)

.....
Tae-eok Jang / General Manager

(name and signature of authorized person)

(Representative in the EU)

Samsung Electronics Euro QA Lab.
Blackbushe Business Park
Saxony Way, Yateley, Hampshire
GU46 6GG, UK

.....
2001-04-03 IS Lee

(place and date of issue)

.....
In-Seop Lee / Manager

(name and signature of authorized person)



ELECTRONICS

EU Declaration of Conformity (RTTE)

Samsung Electronics Co., Ltd.

259 Gongdan-Dong, Gumi-City Kyungbuk, Korea, 730-030

(factory name, address)

declare under our sole responsibility that the product
Digital Keyphone System "DCS-408"

to which this declaration relates is in conformity with

RTTE Directive 1999/5/EC (Annex II)
Low Voltage Directive 73/23/EEC
EMC Directive 89/336/EEC:92/31/EEC



By application of the following standards

EN55022 : 1998 Inc. A1: 2000*

.....
EN61000-3-2:1995 Inc. A1/A2:1998

.....
EN61000-3-3:1995, EN61000-4-2:1995 Inc. A1:1998, EN61000-4-3:1996 Inc. A1:1998

.....
EN61000-4-4:1995, EN61000-4-5:1995, EN61000-4-6:1996, EN61000-4-8:1993

.....
EN61000-4-11:1994, AS/NZS3548:1995

.....
EN60950 ; 1992+A1+A2+A3+A4+A11

(Manufacturer)

Samsung Electronics Co., Ltd
259, Gongdan-Dong, Gumi-City
Kyungbuk, Korea, 730-030

2000-12-08 TE Jang

.....
(place and date of issue)

Tae-eok Jang / General Manager

.....
(name and signature of authorized person)

(Representative in the EU)

Samsung Electronics Euro QA Lab.
Blackbushe Business Park
Saxony Way, Yateley, Hampshire
GU46 6GG, UK

2000-12-08 IS Lee

.....
(place and date of issue)

In-Seop Lee / Manager

.....
(name and signature of authorized person)



ELECTRONICS

EU Declaration of Conformity (RTTE)

Samsung Electronics Co., Ltd.

259 Gongdan-Dong, Gumi-City Kyungbuk, Korea, 730-030

(factory name, address)

declare under our sole responsibility that the product
Digital Keyphone System "DCS-408i"

to which this declaration relates is in conformity with

RTTE Directive 1999/5/EC (Annex II)
Low Voltage Directive 73/23/EEC
EMC Directive 89/336/EEC:92/31/EEC



By application of the following standards

EN55022 : 1998 Inc A1: 2000*

.....
EN61000-3-2:1995 Inc. A1/A2:1998

.....
EN61000-3-3:1995, EN61000-4-2:1995 Inc. A1:1998, EN61000-4-3:1996 Inc. A1:1998

.....
EN61000-4-4:1995, EN61000-4-5:1995, EN61000-4-6:1996, EN61000-4-8:1993,

.....
EN61000-4-11:1994, AS/NZS3548:1995

.....
EN60950 ; 1992+A1+A2+A3+A4+A11

.....

(Manufacturer)

Samsung Electronics co.,ltd
259,Gongdan-Dong,Gumi-City
KyungBuk, Korea 730-030

2001-06-07 TE Jang

.....
(place and date of issue)

Tae-eok Jang / General Manager

.....
(name and signature of authorized person)

(Representative in the EU)

Samsung Electronics Euro QA Lab.
Blackbushe Business Park
Saxony Way, Yateley, Hampshire
GU46 6GG, UK

2001-06-11 IS Lee

.....
(place and date of issue)

In-Seop Lee / Manager

.....
(name and signature of authorized person)



ELECTRONICS

EU Declaration of Conformity (RTTE)

Samsung Electronics Co., Ltd.

259 Gongdan-Dong, Gumi-City Kyungbuk, Korea, 730-030

(factory name, address)

declare under our sole responsibility that the product
Digital Keyphone System "iDCS100"

to which this declaration relates is in conformity with

RTTE Directive 1999/5/EC (Annex II)
Low Voltage Directive 73/23/EEC:93/68/EEC
EMC Directive 89/336/EEC:92/31/EEC



By application of the following standards

EN55022 : 1998, EN55024 : 1998

EN61000-3-2:1995, Inc. A1/A2:1998 + A14:2000

EN61000-3-3:1995, EN61000-4-2:1995 + A1:1998, EN61000-4-3:1996 Inc. A1:1998

EN61000-4-4:1995, EN61000-4-5:1995, EN61000-4-6:1996 + A1

EN61000-4-11:1997, AS/NZS3548:1995

EN60950 : 2000

(Manufacturer)

Samsung Electronics Co., Ltd
259, Gongdan-Dong, Gumi-City
Kyungbuk, Korea, 730-030

2003-03-11 TE Jang

(place and date of issue)

Tae-eok Jang / General Manager

(name and signature of authorized person)

(Representative in the EU)

Samsung Electronics Euro QA Lab.
Blackbushe Business Park
Saxony Way, Yateley, Hampshire
GU46 6GG, UK

2003-03-11 IS Lee

(place and date of issue)

In-Seop Lee / Manager

(name and signature of authorized person)



ELECTRONICS

EU Declaration of Conformity (RTTE)

Samsung Electronics Co., Ltd.

259 Gongdan-Dong, Gumi-City Kyungbuk, Korea, 730-030

(factory name, address)

declare under our sole responsibility that the product

Digital Keyphone System "iDCS500 / OfficeServ500"

to which this declaration relates is in conformity with

RTTE Directive 1999/5/EC (Annex II)
Low Voltage Directive 73/23/EEC
EMC Directive 89/336/EEC:92/31/EEC



By application of the following standards

-
- RTTE: TBR4: November 1995 incorporating TBR4/A1: December 1997
-
- LVD: EN60950: 2000 (IEC 60950, Third Edition, 1999)
-
- EMC: EN55022 : 1998, EN61000-3-2:1995 Inc A1/A2:1998 + A14:2000*,
-
- EN61000-3-3:1995, EN61000-4-2:1995 98, EN61000-4-3:1996,
-
- EN61000-4-4:1995, EN61000-4-5:1995, EN61000-4-6:1996,
-
- EN61000-4-11:1994, AS/NZS3548:1995
-

(Manufacturer)

Samsung Electronics Co., Ltd
259, Gongdan-Dong, Gumi-City
Kyungbuk, Korea, 730-030

2003-05-19 TE Jang

(place and date of issue)

Tae-eok Jang / General Manager

(name and signature of authorized person)

(Representative in the EU)

Samsung Electronics Euro QA Lab.
Blackbushe Business Park
Saxony Way, Yateley, Hampshire
GU46 6GG, UK

2003-05-18 IS Lee

(place and date of issue)

In-Seop Lee / Manager

(name and signature of authorized person)

Digital Keysets

Intended Use

This digital telephone is intended to be connected to a digital extension of a Samsung DCS-408, DCS-408i, DCS-816, iDCS100 or OfficeServ500 telephone system. The connection allows voice communication between the central processor unit and the telephone. It is not intended to be connected to any other telephone system or the public telephone network.

Please read the provided user instructions carefully.

ABOUT THIS GUIDE

This User Guide provides instructions for installing and operating Samsung's latest DS-5038S, 5014S and 5007S 2-line LCD phones with the Samsung DCS-816, DCS-408, DCS-408i, iDCS100 and Enterprise IP Solutions OfficeServ keyphone systems.

Please take the time to read this guide to familiarise yourself with the features of your phone.

SAFETY PRECAUTIONS



For your safety and to ensure correct operation of your phone, note carefully the following important precautions.

Avoid placing objects containing water near the phone.

Do not put objects that contain water such as vases, cups, cosmetics, and medicines near the phone. Moisture in the phone may cause fire and electric shocks.

Do not install the phone in the following locations:

- Direct sunlight or near a heater
- Humid areas or where water flows
- Areas of extreme or volatile changes in temperature.
- Dusty or dirty areas

Use a soft dry cloth to clean the phone.

Do not use chemical solvents such as wax, benzene, alcohol, thinner, aerosol, lubricant, or detergent to clean your phone.

Do not disassemble or attempt to repair the phone yourself.

If a repair is needed, please contact your authorised Samsung dealer.

CONTENTS

INTRODUCTION

About this Guide	1
Safety Precautions	1

PREPARATION

Main Features.....	3
Front View of the Phone	5
Connecting Lines to the Phone.....	7

THINGS YOU SHOULD KNOW

Volume Adjustment.....	8
Entering Characters.....	9
Button LEDs	12

USING THE FEATURES

Making a Call.....	13
Answering a Call.....	17
Features Used During a Call	19

ANNEX

Troubleshooting	23
Product Specifications	25

PREPARATION

Main Features

Speed Dial



For frequently used phone numbers, you can press a speed dial button to make a call.

Pickup



You can answer a call at another extension.

Automatic Redial/Retry



When your call is important but your party is busy on another call, you can use the automatic redial/retry function. The digital phone redials the called number automatically until your party is free to take your call.

Hold

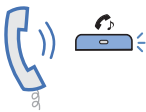

You can use the Hold feature when you need to interrupt a call; for example, when another call arrives. Use this button to temporarily hold the current call until you are ready to resume it. You can even pick up a held call at another station.

Conference Calls



This button is used when multiple parties need to be connected simultaneously during a phone conversation. Up to five parties, including you, can be connected in a conference call.

Call Forwarding

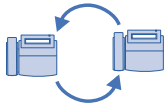

If you cannot answer an incoming call, the call can be forwarded to another extension (unconditionally, while you are busy on a call, or when you are away from your phone).

Do Not Disturb



When you do not want to be disturbed, the DND feature can be set to block incoming calls and the phone will not ring. Your calls can be forwarded to another station when you do not wish to be disturbed.

Paging



If you have an urgent announcement to make, or you wish to locate a colleague, you can page through the speaker of other stations, or through optional external speakers.

Caller ID



When there is an incoming call, the caller ID or name will be displayed on the LCD screen. You can see who is calling before answering the call and respond accordingly.

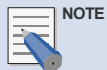

NOTE

If you have any questions or concerns regarding features not covered in this user guide, refer to the other documentation supplied with your system or contact your dealer.

Front View of the Phone

DS-5038S

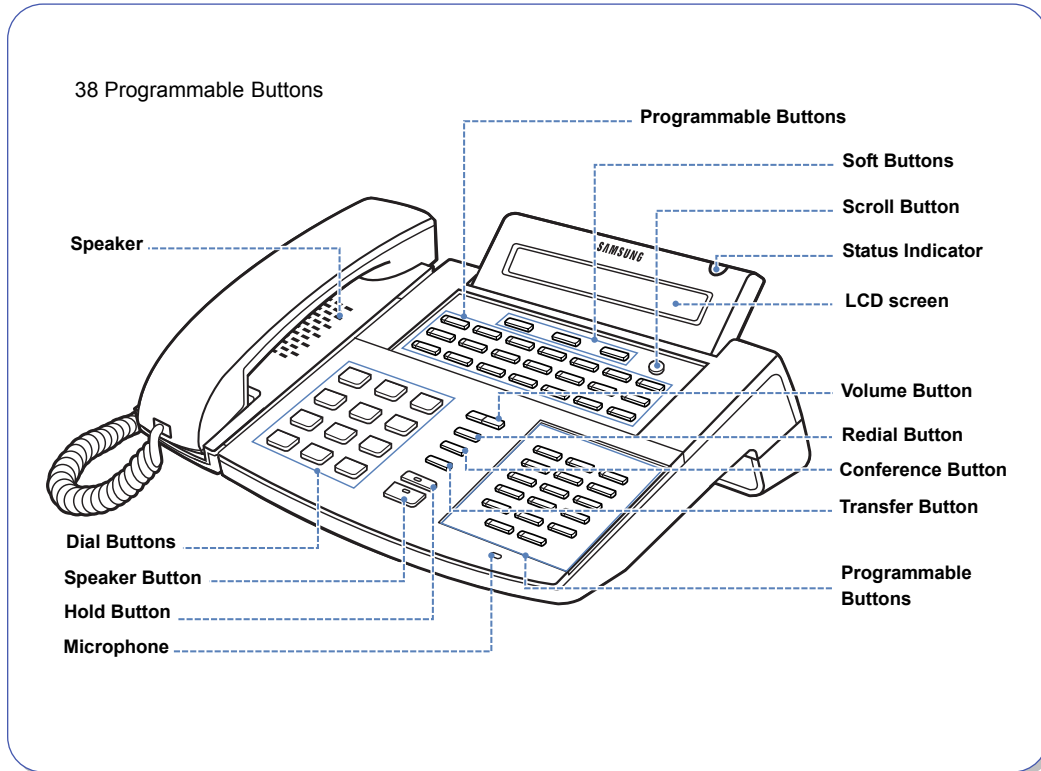

DS-5014S / DS-5007S

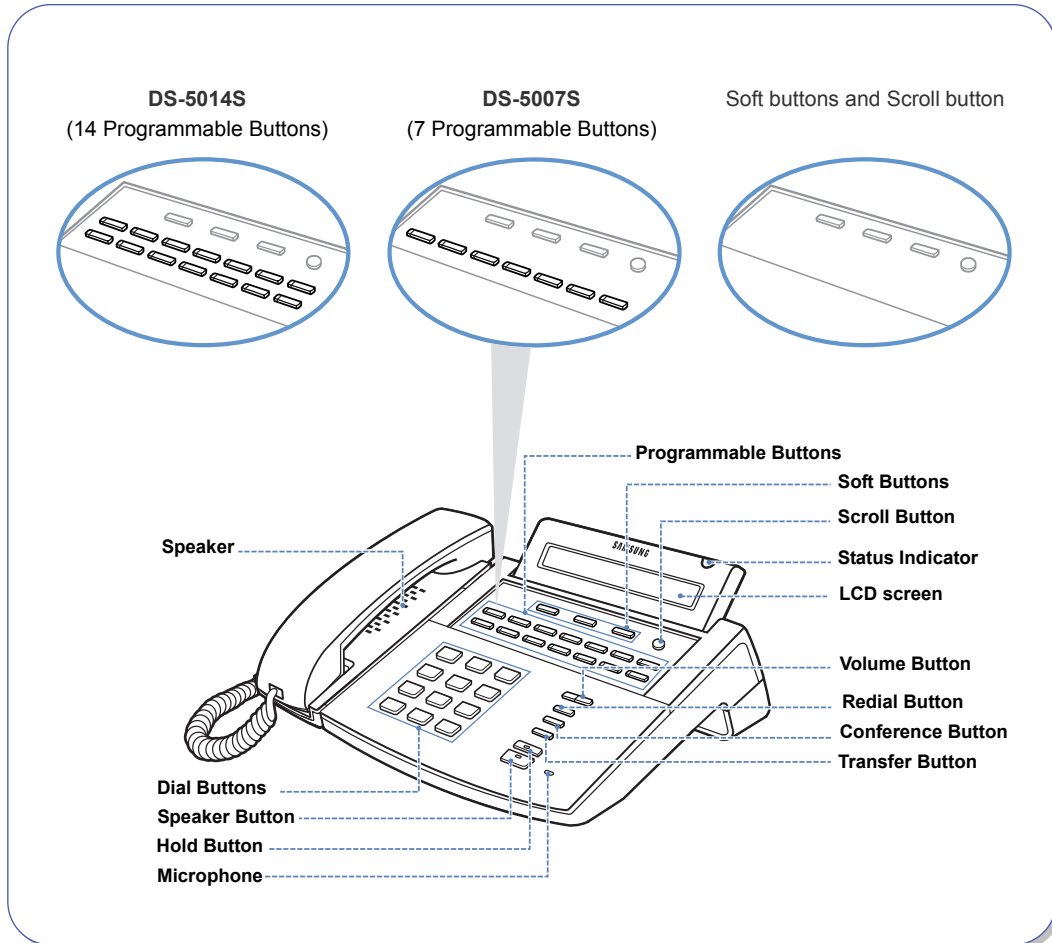

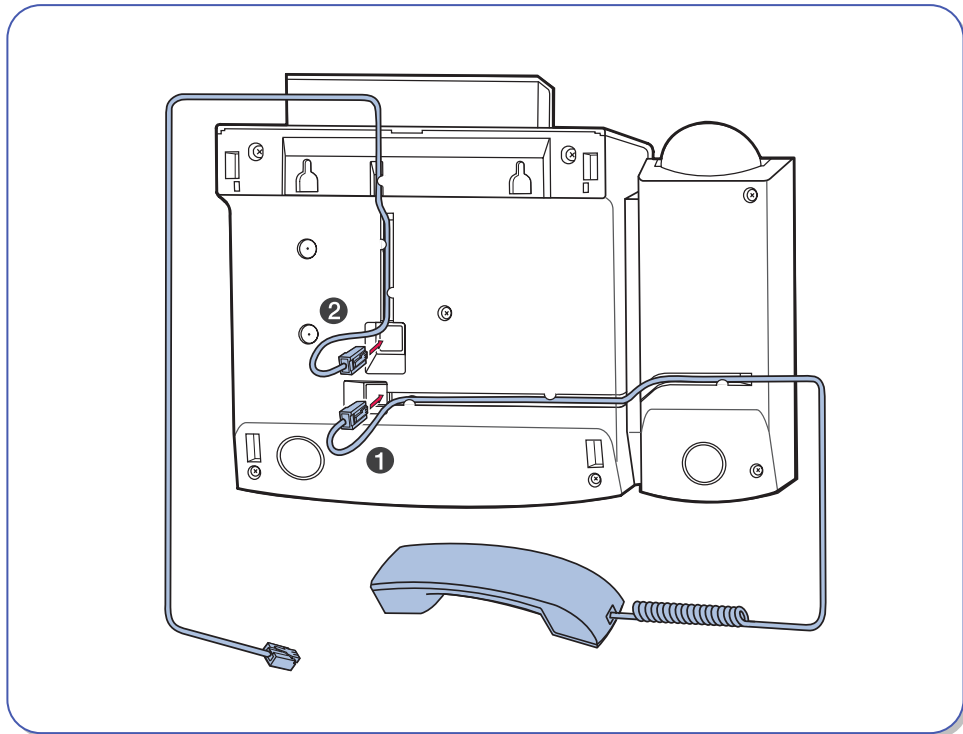

Connecting Lines to the Phone

- 1** Connect the handset to the handset connection jack.
- 2** Connect the line cord to the phone line connection jack.



THINGS YOU SHOULD KNOW

Volume Adjustment

The [ ] button is used for adjusting the volume of the handset, speaker, and ringer.

Adjusting Handset/Speaker Volume

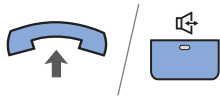

During a call using the handset.

Or, during a call using the **[Speaker]** button.

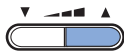

1 Press the **[Volume▲]** button to increase the volume.

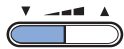

2 Press the **[▼Volume]** button to decrease the volume.

Adjusting Ring Volume

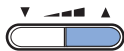

1 To increase the ring volume, press the **[Volume▲]** button while the phone is ringing.



2 To decrease the ring volume, press the **[▼Volume]** button while the phone is ringing.

Entering Characters

Using the dial buttons, you can easily enter and edit characters, numbers and special characters.

“A” Button

The “A” button is used to toggle between uppercase and lowercase characters.

The “A” button of the **DS-5038S**, **DS-5014S**, and **DS-5007S** digital phone is the first button of the bottom row of the programmable buttons below the LCD screen.

DS-5038S

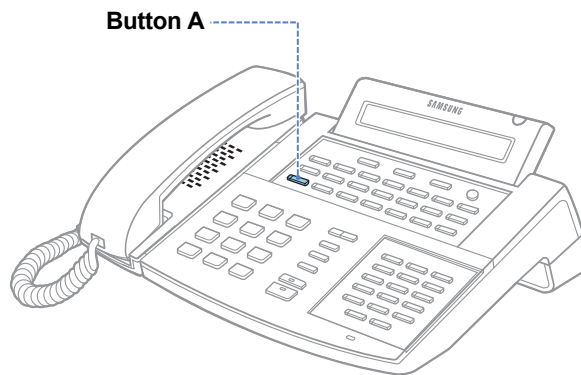

DS-5014S

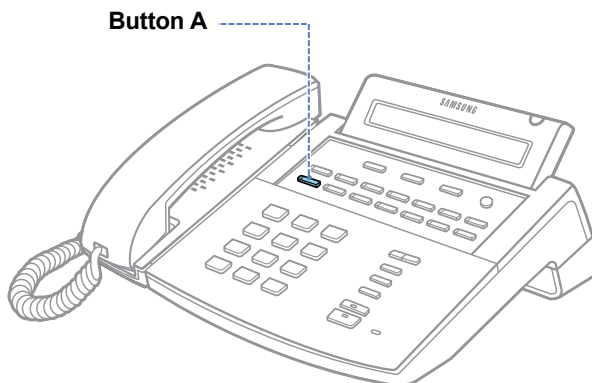

DS-5007S

Button A

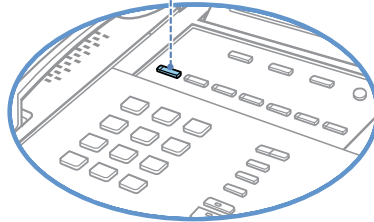

Procedure

Press the [▼ ▸ ▲] button to move the cursor and insert or modify the desired character.
Press the [▼ ▸ ▲] button to move the cursor one space to the right to enter the same character you previously selected.

Procedures for entering characters are described below.

Enter the characters according to the table below. Press button “A” to switch between uppercase and lowercase characters.

Dial frequency \ Dial button	1	2	3	4	5
0	<	>	.)	0
1	Space	?	,	!	1
2	A	B	C	@	2
3	D	E	F	#	3
4	G	H	I	\$	4
5	J	K	L	%	5
6	M	N	O	^	6
7	P	Q	R	S	7
8	T	U	V	*	8
9	W	X	Y	Z	9
*	:	=	[]	*
#	# ? - [) 	Space . <] _ ;	& , > @ + "	! % / ^ { →	: \$ = (} ,

Press the [#] button to enter special characters. Special characters are displayed in the following order.

► space ► & ► ! ► : ► ? ► . ► , ► % ► \$ ► - ► < ► > ► / ► =
► [►] ► @ ► ^ ► (►) ► _ ► + ► { ► } ► | ► ; ► " ► → ► ' ►

Button LEDs

The **[Transfer]** button, **[Hold]** button, and **[Speaker]** button have LEDs that turn on or off according to the phone status.

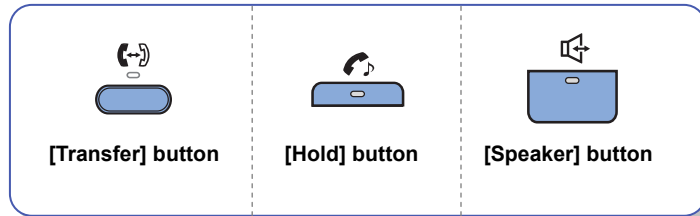

For incoming external calls or intercom calls ringing at your phone the trunk button LED or Call button LED will flash green. The trunk button LED will flash red on other digital phones with the same trunk button. While holding a call, the green LED of the trunk line will flash.

The following table summarises the status of LEDs.

Function	Button LED Status
Trunk line or functions are in use	LED is steady green or red.
New call is ringing	LED is a fast flashing green.
A call is on hold	LED is a slow flashing green or red.
A call is recalling to the digital phone	LED is a slow flashing amber.

USING THE FEATURES

Making a Call

This function is used when you want to make a call to other stations or to make an external call.

Calling an Extension Number

This function is used when you want to make a call to other stations.



- 1** Pick up the handset and check for dial tone.

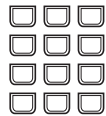

- 2** Dial the extension number or station group number.
Wait until the other party answers the call.
If a short signal tone (not a ringing tone) is heard, the receiving extension has set up the Voice Announce or Automatic Answer function.

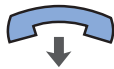

- 3** Replace the handset to finish the call.

Calling an Outside number

This function is used when you want to make an external call.



1 Pick up the handset.

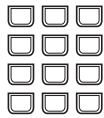

2 Press the trunk or trunk group button or dial the trunk group access code (e.g., 9).

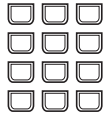

3 Dial the telephone number you want to call.



4 Finish your call by replacing the handset.



NOTE

If the hot keypad feature is used, you can make an external call without picking up the handset by dialling the trunk access code.

Using a Speakerphone

This function is used when you make a call with the speakerphone.



- 1 Press the **[Speaker]** button without lifting the handset.

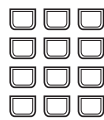

- 2 Dial the telephone number you want to call.
Or, press the trunk line / extension button.

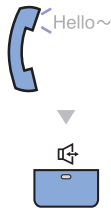

- 3 Finish the call, by pressing the **[Speaker]** button.

New Call



- 1 Press the **[NEW]** button to disconnect your existing call, wait for dial tone and then make a new call on the same line.
If the **[NEW]** button does not appear on your phone, press the Soft button corresponding to **[NEW]** on the LCD screen.

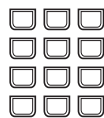

- 2 Check for dial tone and then dial the telephone number.

Redial

To redial the last outside telephone number you dialed.



Press the **[Redial]** button. Or, dial **[1][9]**.

Save Number with Redial

To save the number you just dialed for later use.



- 1** Press the **[SNR]** button before hanging up. If the **[SNR]** button does not appear on your phone, press the Soft button corresponding to **[SAVE]** on the LCD screen.



- 2** The saved number can be redialled at any time by pressing the **[SNR]** button or dialling **[1][7]**. The same external trunk line will be selected for you.

Answering a Call

This function is used when you want to answer an intercom or outside call.

Using a Handset

This function is used when you answer a call with the handset.

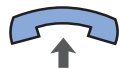

1 When the phone rings, pick up the handset.

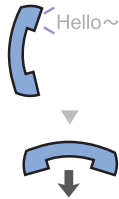

2 To finish the call replace the handset.

Using the Speakerphone

This function is used when you answer a call with the speakerphone.



1 When the phone rings, press the **[Speaker]** button without lifting the handset.

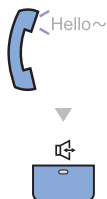

2 To finish the call, press the **[Speaker]** button.



NOTE

If a call is flashing at your phone but not ringing, you must press the flashing button to answer.

Call Pickup

This function is used when you pick up a call ringing at another station.



1 When a call is ringing at another station, pick up the handset and listen for the dial tone.



2 Dial **[6][5]**.

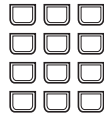

3 Dial the number of the ringing station.

Features Used During a Call

These features are used while you are on a call.

Hold an Intercom Call

You can put the other party on hold if another intercom call arrives or you wish to use both hands for another task and resume the call later.



1 Press the **[Hold]** button during a call.



2 Replace the handset to put the current call on hold.

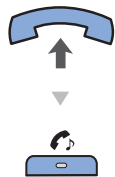

3 To resume the call, lift the handset and then press the **[Hold]** button.

Hold an Outside Call

You can put the other party on hold if another external call arrives or you wish to use both hands for another task and resume the call later.



- 1 While you are engaged in a conversation, press the **[Hold]** button.



- 2 The call on hold will flash green on your phone and this line will flash red on other stations.

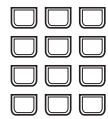

- 3 To return to the held call, press the line button. The green LED will stop flashing.



- 4 Resume your conversation with the other party.



NOTE

While you are on a call, pressing a trunk line button or flashing Call button can automatically put your first call on hold and connect you to the new call, if the automatic hold feature is set. See your system administrator for advice.

Mute

During a call you can mute the handset transmitter or microphone while still listening to the other party.



- 1 Press the **[MUTE]** button. A red LED lights on the button. If the **[MUTE]** button does not appear on your phone, press the Soft button corresponding to **[MUTE]** on the LCD screen.



- 2 To clear the Mute function, press the **[MUTE]** button again.

Transferring a Call

You can transfer your call to another extension or return to the outside party.



- 1 While on a call, press the **[Transfer]** button. Your call is automatically put on transfer hold.

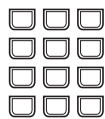

- 2 Dial an extension number or trunk line number.

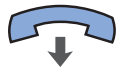

- 3 For blind transfer, hang up when you hear ringing. Or, for screened transfer, wait for the called party to answer and advise them of the call. Then hang up.

Conference Calls

Up to 5 members, including you, can participate in a conference simultaneously.



- 1 Press the **[Conference]** button while on a call. You will hear conference tone.

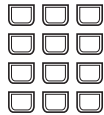

- 2 Dial the number of the internal or external party you wish to add to the conference, wait for them to answer and press the **[Conference]** button again.



- 3 Dial the number of another internal or external party to be added to the conference, or press the **[Conference]** button to begin the conference.

The conference connection status of all the numbers is displayed.

- When you have added the last party press the **[Conference]** button twice.
- To disconnect a party from the conference, press the **[Conference]** button and dial the station number or trunk number of the party to be excluded. Press **[Conference]** again to resume the conference with the remaining parties.



NOTE

Alternatively, you can press the **[*6]** button and dial the conference function code **[4][6]** to use the conference function to add additional parties.

ANNEX

Troubleshooting

Possible problems and their normal solutions are described below. Check this list before contacting your Samsung dealer for advice.

? Dial tone is not heard when you lift the handset or press the [Speaker] button.

Check that the handset and phone line are connected to the handset connection jack and phone line connection jack of the phone.
(Refer to '**Connecting Lines to the Phone**' in this guide.)

? Nothing appears on the LCD screen while the phone is being used.

Check that the phone line is connected to the phone line connection jack of the phone.
(Refer to '**Connecting Lines to the Phone**' in this guide.)

? The phone does not ring or the volume is too low.

Press the [▼  ▲] button to adjust the volume.
(Refer to '**Volume Adjustment**' in this guide.)

? Conversation quality is reduced due to noise and echo.

If you are using the speakerphone, try using the handset.

? Excessive echo occurs during a page announcement or with Auto Answer set.

If digital phones are too close to each other, sound from one speaker might echo during a page or on auto answer call. Maintain a reasonable distance between digital phones.

? Caller IDs are not displayed on the LCD screen.

- Confirm with your system administrator that the caller ID service is available from your Telephone Company.
- The caller may have blocked the sending of their caller ID.
- The caller may be making a call from an area where the caller ID cannot be provided (e.g., international calls).
- The caller may be using a public phone.
- The caller ID received from the Telephone Company may be corrupt.
- The Telephone Company may not send a caller ID.

? An alarm does not ring at the programmed time.

- Check if the current time is set on the phone correctly, and if the alarm is set. (See your system administrator.)

Product Specifications

The specifications of the DS-5038S, DS-5014S, and DS-5007S digital phones are as follows.

Item	Specification		
Model Name	DS-5038S	DS-5014S	DS-5007S
Weight (kg)	0.962	0.830	
Size (mm) (width×length×height)	266×206×119	235×206×100	
Operating Temperature (°C)	0 to 45		
Operating Humidity (%)	10 to 90 non-condensing		
Number of [Programmable] buttons	38	14	7
Speakerphone	Yes		
AOM	64-button AOM can be connected (software connection)		
Telephone line thickness	26AWG (or above)		
LCD	2-Line LCD 24 characters per line: English		

Samsung Telecoms (U.K.) Limited
Brookside Business Park, Greengate, Middleton, Manchester M24 1GS

